



# Solid State Relays Zero Switching Types RGS Solid State Relay 'E' connection



- 17.5mm width
- Rated Operational voltage: Up to 600Vrms
- Rated Operational current: Up to 90Arms
- Up to 6600A<sup>2</sup>s for I<sup>2</sup>t
- Control voltages: 3-32 VDC, 20-275 VAC (24-190VDC)
- Input connection: Screw terminal or pluggable spring
- Output connection: Screw clamp/screw terminal
- Design according to IEC/EN60947-4-2, IEC/EN60947-4-3, IEC/EN62314, UL508, CSA22.2 No. 14-10
- Integrated voltage transient protection with varistor
- RoHS compliant
- Short circuit rating: 100 kA
- VDE approval (pending)

## Product Description

Aim of this solid state switching device is to switch heater loads and motor loads frequently. The range offers solutions up to 90AAC in 17.5mm width. Output connections are via a screw connection, having a captivated washer allowing for safe looping. Input connection is provided either via a screw

connection having a captivated washer or via a pluggable spring loaded input. Other options with integrated heatsink are available in RGC ranges.

Specifications are at a surrounding temperature of 25°C unless otherwise specified.

## Ordering Key **RGS 1 A 60 D 75 K K E**

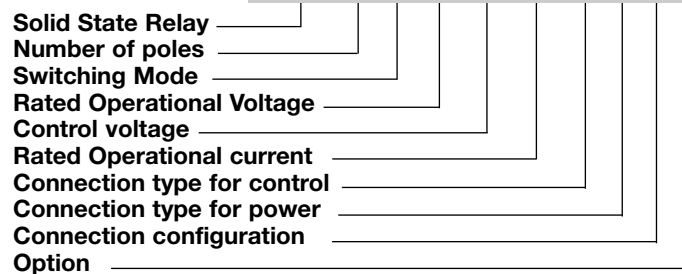

## Ordering Key

1Phase SSR with no heatsink	Rated Voltage	Control Voltage	Rated Current	Connection Control	Connection Power	Connection Configuration
<b>RGS1A: ZC</b>	23: 230V +10% - 15%	D: 3 - 32 VDC (4-32VDC)	25: 25A, 1200Vp 50: 50A, 1200Vp	K: Screw M: pluggable	K: Screw	E: Contactor
<b>RGS1B: IO</b>	60: 600V +10% -15%	A: 20 - 275VAC (24-190 VDC)	51: 50A, 1600Vp 75: 75A, 1200Vp 71: 75A, 1600Vp 90: 90A, 1200Vp 91: 90A, 1600Vp	spring-loaded		

## Selection Guide (ZC = Zero Cross Switching, IO = Instant-On Switching)

Rated Output Voltage	Blocking Voltage	Connection Control/ Power	Control Voltage	Rated operational current @ 40°C			
				25 AAC	50 AAC	75 AAC	90 AAC
230VAC, ZC	800Vp	Screw/Screw	3-32VDC	RGS1A23D25KKE	RGS1A23D50KKE	RGS1A23D75KKE	-
		Spring/Screw	3-32VDC	RGS1A23D25MKE	RGS1A23D50MKE	-	-
		Screw/Screw	20-275VAC, 24-190VDC	RGS1A23A25KKE	RGS1A23A50KKE	RGS1A23A75KKE	-
		Spring/Screw	20-275VAC, 24-190VDC	RGS1A23A25MKE	RGS1A23A50MKE	-	-
600VAC, ZC	1200Vp	Screw/Screw	4-32VDC	RGS1A60D25KKE	RGS1A60D50KKE	RGS1A60D75KKE	RGS1A60D90KKE
		Spring/Screw	4-32VDC	RGS1A60D25MKE	RGS1A60D50MKE	RGS1A60D75MKE	RGS1A60D90MKE
		Screw/Screw	20-275VAC, 24-190VDC	RGS1A60A25KKE	RGS1A60A50KKE	RGS1A60A75KKE	RGS1A60A90KKE
		Spring/Screw	20-275VAC, 24-190VDC	RGS1A60A25MKE	RGS1A60A50MKE	RGS1A60A75MKE	RGS1A60A90MKE
	1600Vp	Screw/Screw	4-32VDC	-	RGS1A60D51KKE	RGS1A60D71KKE	RGS1A60D91KKE
		Screw/Screw	20-275VAC, 24-190VDC	-	RGS1A60A51KKE	RGS1A60A71KKE	RGS1A60A91KKE
600VAC, IO	1200Vp	Screw/Screw	4-32VDC	RGS1B60D25KKE	RGS1B60D50KKE	RGS1B60D75KKE	RGS1B60D90KKE

## Output Voltage Specifications

		RGS..23..	RGS..60..
Operational Voltage Range		24-240 VAC, +10%, -15% on max	42-600 VAC, +10% -15% on max
Blocking Voltage	RGS..25/50/75/90 RGS..51/71/91	800Vp -	1200 Vp 1600 Vp
Internal Varistor	RGS..25/50/75/90 RGS..51/71/91	275V -	625V 680 V

## General Specifications

Latching voltage (across L1-T1)	≤20V	Pollution degree	2 (non-conductive pollution with possibilities of condensation)
Operational frequency range	45 to 65Hz	Over-voltage category	III (fixed installations)
Power factor	> 0.5 @ Vrated	Isolation	
CE marking	Yes	Input to Output	4000Vrms
Finger Protection	IP20	Input&Output to Case	4000Vrms
Control input status	continuously ON Green LED, when control input is applied		

## Input specifications (@ 25°C unless otherwise specified)

		RGS..D.. <sup>1</sup>	RGS..A..
Control voltage range	RGS..23..	3 - 32 VDC	20 - 275 VAC, 24 (-10%) - 190 VDC
	RGS..60..	4 - 32 VDC	20 - 275 VAC, 24 (-10%) - 190 VDC
Pick-up voltage	RGS..23.. RGS..60..	3.0 VDC 3.8 VDC	20 VAC/DC
Drop-out voltage	RGS..23.. RGS..60..	1 VDC 1 VDC	5 VAC/DC
Maximum Reverse voltage		32 VDC	-
Response time pick-up ZC (RGS1A..)		0.5 cycle + 500µs @ 24VDC	2 cycles @ 230VAC/110VDC
Response time pick-up IO (RGS1B..)		350µs @ 24 VDC	N/A
Response time drop-out		0.5 cycle + 500µs @ 24VDC	0.5 cycle + 40ms @ 230 VAC/ 110 VDC
Input current @ 40°C		See diagrams below	See diagrams below

1: DC control to be supplied by a Class 2 power source

### RG..D..

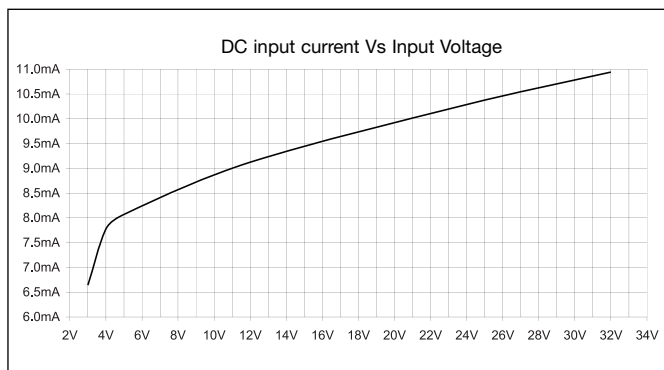

### RG..A..

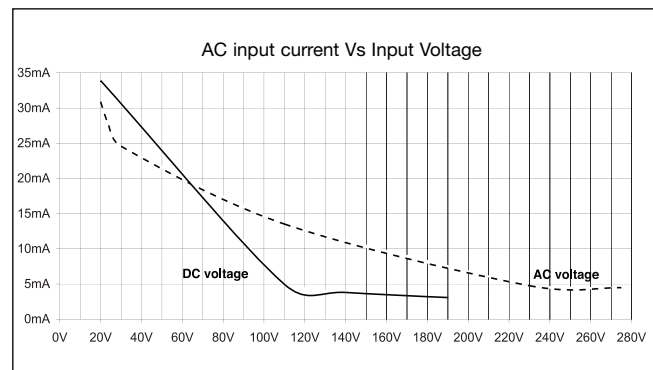

## Motor Ratings<sup>2</sup>: HP (UL508) / kW (IEC60947-4-2) @ 40°C

	115 VAC	230 VAC	400 VAC	480 VAC	600 VAC
RGS..25	½HP / 0.18kW	1-½HP / 0.37kW	3HP / 0.75kW	3HP / 1.1kW	5HP / 1.5kW
RGS..50/51	1HP / 0.37kW	3HP / 1.1kW	5HP / 1.5kW	5HP / 2.2kW	7-½HP / 3.7kW
RGS..75/71	1-½HP / 0.56kW	3HP / 1.5kW	5HP / 3kW	7-½HP / 4kW	10HP / 4kW
RGS..90/91	2HP / 0.75kW	5HP / 2.2kW	7-½HP / 4kW	10HP / 4kW	15HP / 5.5kW

2: Refer to heatsink selection table

## Output specifications

	RGS..25..	RGS..50/51..	RGS..75/71..	RGS..90/91..
Rated operational current AC51 @ Ta=40°C (IEC60947-4-3/UL508) <sup>2</sup>	25 AAC	50 AAC	75 AAC	90 AAC
AC-53a rating @ Ta=40°C (IEC60947-4-2/ UL508)	5 AAC	10 AAC	14.8 AAC	18 AAC
Number of motor starts (x:6, Tx:6s, F:50%) at 40°C <sup>2, 3</sup>	30	30	30	30
Min. operational current	150 mAAC	250 mAAC	400 mAAC	400 mAAC
Rep. overload current - UL508: T <sub>AMB</sub> =40°C, t <sub>ON</sub> =1s, t <sub>OFF</sub> =9s, 50cycles	67 AAC	107 AAC	126 AAC	168 AAC
Maximum Transient Surge Current (I <sub>TSM</sub> )	325Ap	600Ap	800Ap	1150Ap
Maximum Off-state leakage current	3 mAAC	3 mAAC	3 mAAC	3 mAAC
I <sup>2</sup> t (10ms) Typical	525 A <sup>2</sup> s	1800A <sup>2</sup> s	RG..75: 3200A <sup>2</sup> s RG..71: 6600A <sup>2</sup> s	6600A <sup>2</sup> s
Critical dv/dt (@ T <sub>j</sub> init = 40°C)	1000V/us	1000V/us	1000V/us	1000V/us

3 x: multiple of AC-53a current rating, Tx: duration of current surge, F: duty cycle.

## Output Power Dissipation

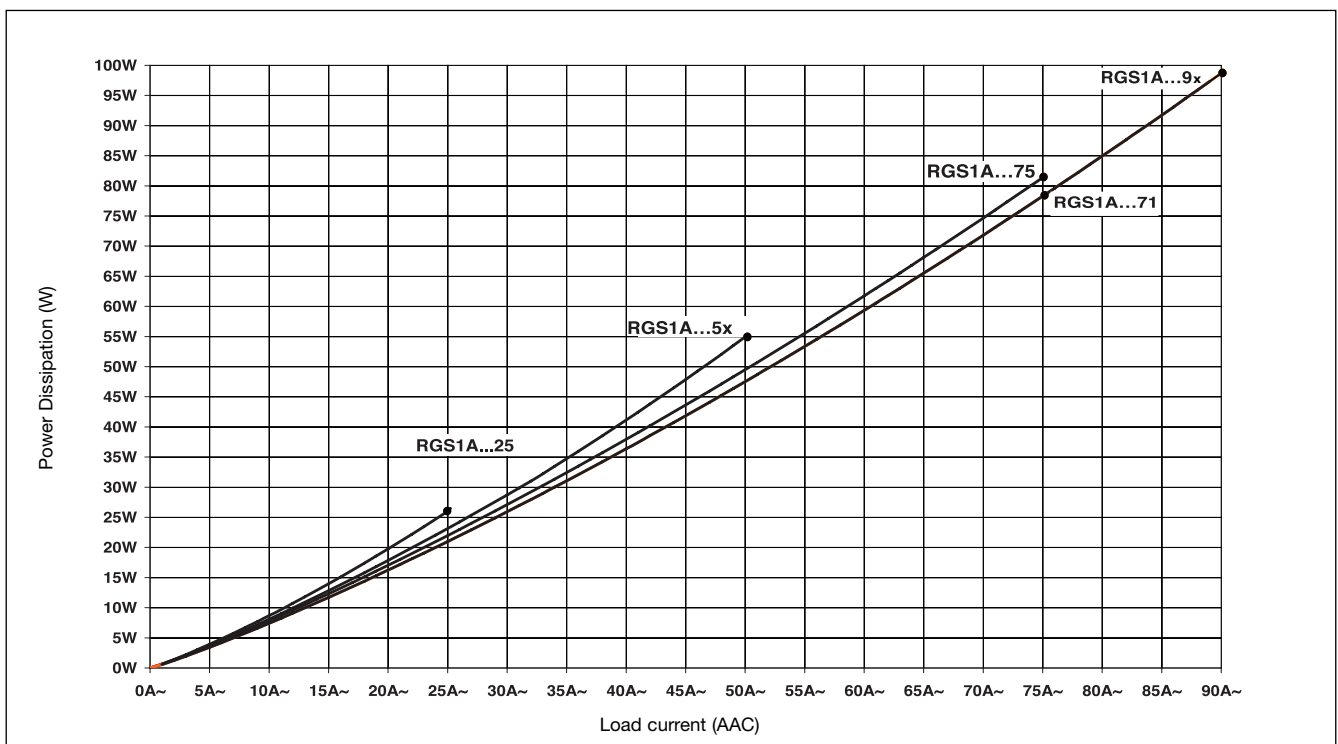

## Electromagnetic Compatibility

<b>EMC Immunity</b>	IEC/EN 61000-6-2	<b>Radiated Radio Frequency Immunity</b>	IEC/EN 61000-4-3
<b>Electrostatic Discharge (ESD) Immunity</b>	IEC/EN 61000-4-2	10V/m, 80 - 1000 Mhz	Performance Criteria 1
Air discharge, 8kV	Performance Criteria 1	10V/m, 1.4 - 2.0GHz	Performance Criteria 1
Contact, 4kV	Performance Criteria 1	3 V/m, 2.0 - 2.7GHz	Performance Criteria 1
<b>Electrical Fast Transient (Burst) Immunity</b>	IEC/EN 61000-4-4	<b>Conducted Radio Frequency Immunity</b>	IEC/EN 61000-4-6
Output: 2kV, 5kHz	Performance Criteria 1	10V/m, 0.15 - 80 MHz	Performance Criteria 1
Input: 1kV, 5kHz	Performance Criteria 1	<b>Voltage Dips Immunity</b>	IEC/EN 61000-4-11
<b>Electrical Surge Immunity</b>	IEC/EN 61000-4-5	0% for 10ms/20ms	Performance Criteria 2
Output, line to line, 1kV	Performance Criteria 1	40% for 200ms	Performance Criteria 2
Output, line to earth, 2kV	Performance Criteria 1	70% for 500ms	Performance Criteria 2
Input, line to line, 1kV	Performance Criteria 2	<b>Voltage Interruptions Immunity</b>	IEC/EN 61000-4-11
Input, line to earth, 2kV	Performance Criteria 2	0% for 5000ms	Performance Criteria 2
<b>EMC Emission</b>	EN/IEC 61000-6-4	<b>Radio Interference</b>	
<b>Radio Interference</b>		<b>Field Emission (Radiated)</b>	IEC/EN 55011
<b>Voltage Emission (Conducted)</b>	IEC/EN 55011	<b>30 - 1000MHz</b>	Class A (industrial)
<b>0.15 - 30MHz</b>	Class A (industrial) with filters - see filter information		
	IEC/EN 60947-4-2, 60947-4-3		
	Class A (no filtering needed)		

## Filtering - EN / IEC 55011 Class A compliance (for class B compliance contact us)

Part Number	Suggested filter for compliance	Maximum Heater current
RGS1A23..25	100 nF / 275 V / X1	25 A
RGS1A23..50	220 nF / 275 V / X1	30 A
	330 nF / 275 V / X1	35 A
RGS1A23..51	150 nF / 275 V / X1	20 A
	220 nF / 275 V / X1	35 A
RGS1A23..75	330 nF / 275 V / X1	35 A
RGS1A23..71/90/91	330 nF / 275 V / X1	35 A
RGS1A60..25	150 nF / 760 V / X1	25 A
	220 nF / 760 V / X1	30 A
RGS1A60..50	330 nF / 760 V / X1	30 A
RGS1A60..51	220 nF / 760 V / X1	30 A
RGS1A60..75	220 nF / 760 V / X1	30 A
RGS1A60..71/90/91	220 nF / 760 V / X1	30 A

### Note:

- Control input lines must be installed together to maintain products' susceptibility to Radio Frequency interference. Use of AC solid state relays may, according to the application and the load current, cause conducted radio interferences. Use of mains filters may be necessary for cases where the user must meet E.M.C requirements. The capacitor values given inside the filtering specification tables should be taken only as indications, the filter attenuation will depend on the final application. DC input type require surge suppression for full compliance to EN55011.
- Performance Criteria 1: No degradation of performance or loss of function is allowed when the product is operated as intended.
- Performance Criteria 2: During the test, degradation of performance or partial loss of function is allowed. However when the test is complete the product should return operating as intended by itself.
- Performance Criteria 3: Temporary loss of function is allowed, provided the function can be restored by manual operation of the controls.

## Filter Connection diagram

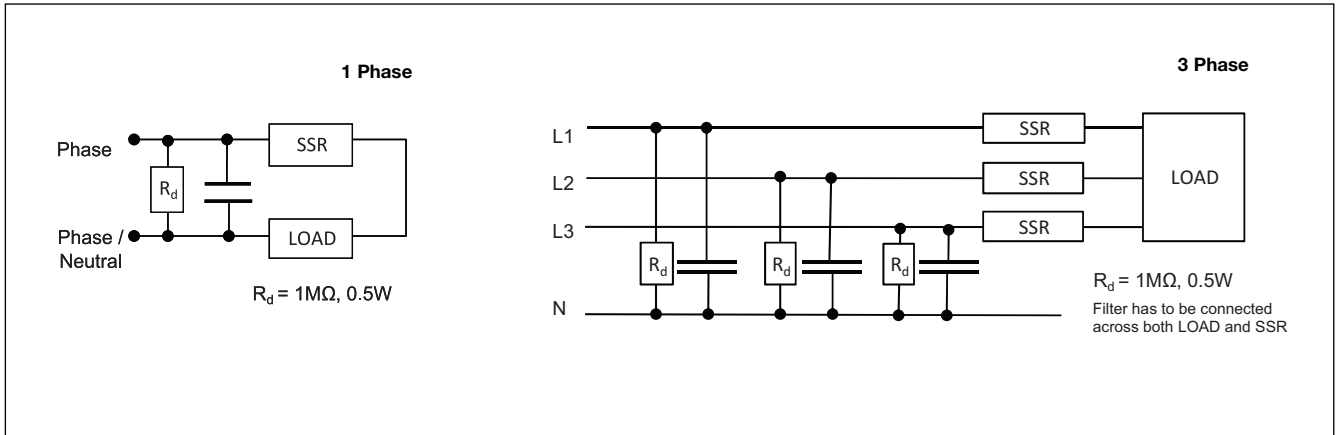

## Terminal Layout and Dimensions

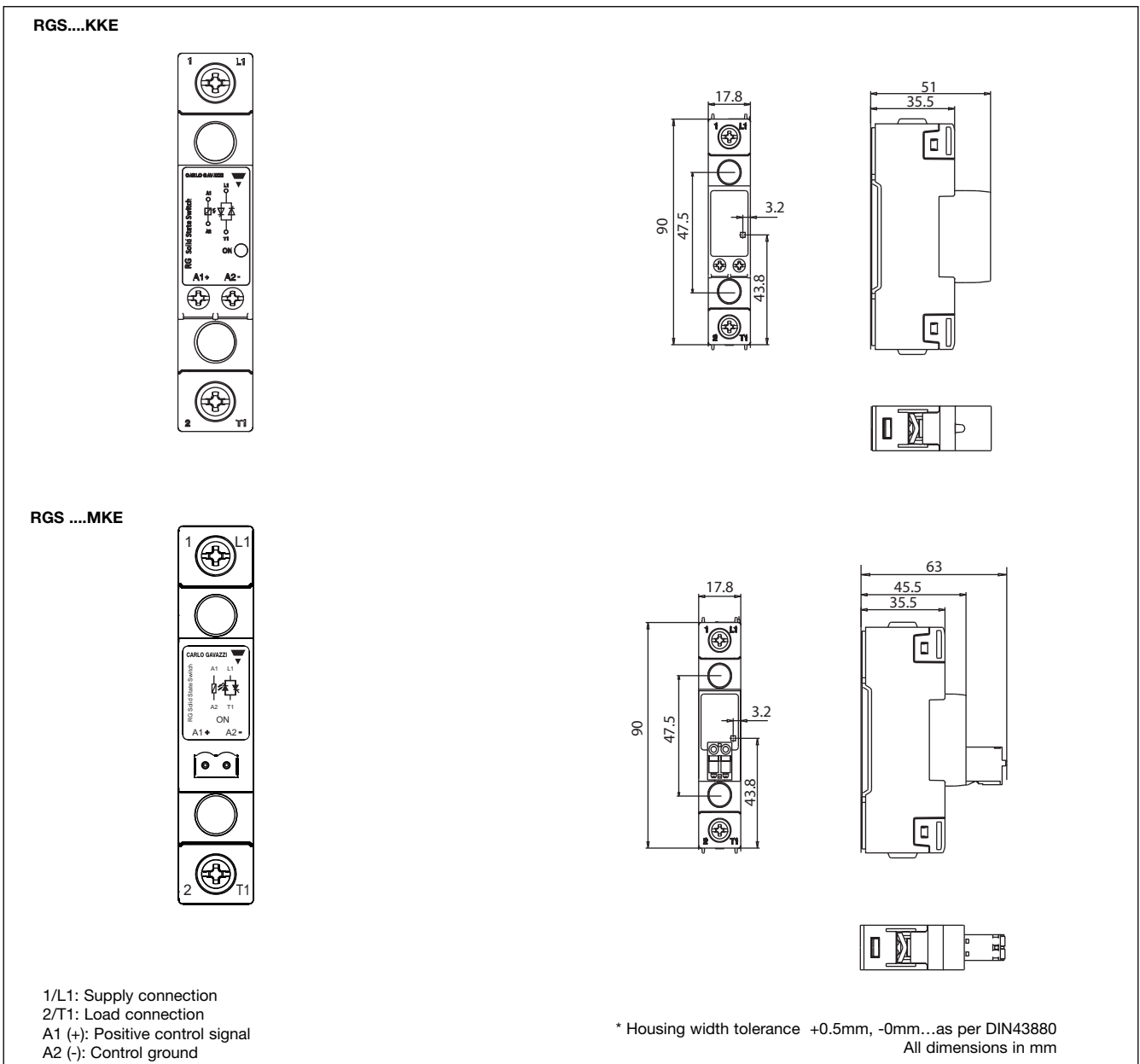

## Connection Specifications

### POWER CONNECTIONS: 1/L1, 2/T2

#### Torque specifications



2 Nm (17.7 in-lb)  
M4, Pozidriv 2  
Use 75°C copper (Cu)  
conductors  
Stripping Length (X) = 12mm

#### Rigid (Solid & Stranded)

UL/ CSA rated data

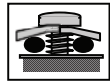
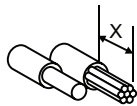

2 x 2.5..6 mm<sup>2</sup>  
2 x 14..10 AWG

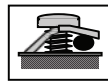

1 x 2.5..6 mm<sup>2</sup>  
1 x 14..10 AWG

#### Flexible with end sleeve



2 x 2.5..4mm<sup>2</sup>  
2 x 14..12AWG

1 x 2.5..4mm<sup>2</sup>  
1 x 14..12AWG

#### Flexible without end sleeve



2 x 2.5..6 mm<sup>2</sup>  
2 x 14..10 AWG

1 x 2.5..6 mm<sup>2</sup>  
1 x 14..10 AWG

#### Aperture for termination lug

12.3mm

### CONTROL CONNECTIONS: A1(+), A2(-) for RGS...KKE

#### Torque specifications



0.5 Nm (4.4 in-lb)  
M3, Pozidriv 1  
Use 60/75°C copper (Cu)  
conductors  
Stripping Length (X) = 8mm

#### Rigid (Solid & Stranded)

UL/ CSA rated data

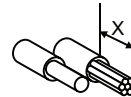

2 x 0.5..2.5mm<sup>2</sup>  
2 x 18..12 AWG

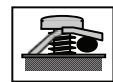

1 x 0.5..2.5mm<sup>2</sup>  
1 x 18..12 AWG

#### Flexible with end sleeve



2 x 0.5..2.5mm<sup>2</sup>  
2 x 18..12AWG

1 x 0.5..2.5mm<sup>2</sup>  
1 x 18..12AWG

### CONTROL CONNECTIONS: A1(+), A2(-) for RGS...MKE

Use 60/75°C copper (Cu) conductors

#### Stripping Length (X)

12 - 13mm

#### Rigid (Stranded)

UL/ cUL rated data

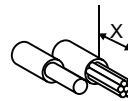

1 x 0.2...2.5mm<sup>2</sup>  
1 x 24 ... 12 AWG

## Environmental Specifications

Operating Temperature	-40°C to 80°C (-40°F to +176°F)	Vibration resistance (2-100Hz, IEC60068-2-26)	5g
Storage Temperature	-40°C to 100°C (-40°F to +212°F)	Relative humidity	95% non-condensing @ 40°C
RoHS (2002/95/EC)	Compliant	UL flammability rating (housing)	UL 94 V0
Impact resistance (IEC60068-2-27)	15/11 g/ms		

## Connection Diagram

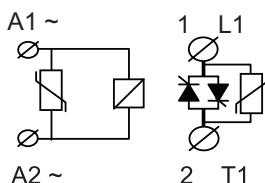

In AC controlled types only (RG..A..) a varistor is placed across A1/A2 terminals.

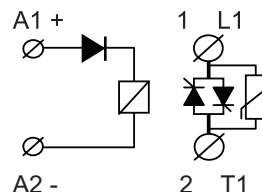

In DC controlled types only (RG..D..) a diode is placed in series with the control circuit for protection against reverse biased connection.

## Heatsink Selection

In suggesting the below values for the heatsink thermal resistance, junction temperature was taken as maximum 125°C and heatsink temperature as maximum 100°C.

### RGS1A..25

Load current [A]	Thermal resistance [K/W]							Power dissipation [W]
	20	30	40	50	60	70	80	
25.0	3.11	2.72	2.33	1.94	1.55	1.17	0.78	25.7
22.5	3.55	3.10	2.66	2.22	1.77	1.33	0.89	22.6
20.0	4.104	3.59	3.08	2.57	2.05	1.54	1.03	19.5
17.5	4.83	4.23	3.63	3.02	2.42	1.81	1.21	16.6
15.0	5.83	2.10	4.37	3.64	2.91	2.19	1.46	13.7
12.5	7.224	6.34	5.43	4.53	3.62	2.72	1.81	11.0
10.0	9.43	8.25	7.07	5.89	4.71	3.54	2.36	8.5
7.5	13.17	11.53	9.88	8.23	6.59	4.94	3.29	6.
6.4	15.81	13.84	11.86	9.88	7.90	5.93	3.95	5.1
3.2	34.76	30.42	26.07	21.73	17.38	13.04	8.69	2.3
	T <sub>A</sub>							
	Ambient temp [°C]							

### RGS1A..5x

Load current [A]	Thermal resistance [K/W]							Power dissipation [W]
	20	30	40	50	60	70	80	
50.0	1.45	1.28	1.09	0.91	0.73	0.55	0.37	54.8
45.0	1.68	1.47	1.26	1.05	0.84	0.63	0.42	47.7
40.0	1.96	1.71	1.47	1.22	0.98	0.73	0.49	40.9
35.0	2.32	2.03	1.74	1.45	1.61	0.87	0.58	34.5
30.0	2.82	2.47	2.12	1.76	1.41	1.06	0.71	28.3
25.0	5.52	3.08	2.64	2.20	1.76	1.32	0.88	22.7
20.0	4.58	4.01	3.44	2.87	2.29	1.72	1.15	17.5
15.0	6.40	5.60	4.80	4.00	3.20	2.40	1.60	12.5
10.0	10.19	8.92	7.64	6.37	5.10	3.82	2.55	7.8
5.0	22.30	19.51	16.72	13.94	11.15	8.36	5.57	3.6
	T <sub>A</sub>							
	Ambient temp [°C]							

### RGS1A..71

Load current [A]	Thermal resistance [K/W]							Power dissipation [W]
	20	30	40	50	60	70	80	
75.0	1.03	0.90	0.77	0.64	0.51	0.39	0.26	77.9
67.5	1.17	1.03	0.88	0.73	0.59	0.44	0.29	68.2
60.0	1.36	1.90	1.02	0.85	0.68	0.51	0.34	58.9
52.5	1.60	1.40	1.20	1.00	0.80	0.60	0.40	49.9
45.0	1.93	1.69	1.45	10.21	0.97	0.73	0.48	41.4
37.5	2.41	2.11	1.81	1.51	1.20	0.90	0.60	33.2
30.0	3.14	2.75	2.35	1.96	1.57	1.18	0.78	25.5
22.5	4.39	3.84	3.29	2.74	2.19	1.65	1.10	18.2
15.0	6.99	6.12	5.24	4.37	3.50	2.62	1.75	11.4
7.2	15.29	13.38	11.47	9.56	7.65	5.73	3.82	5.2
	T <sub>A</sub>							
	Ambient temp [°C]							

### RGS1A..75

Load current [A]	Thermal resistance [K/W]							Power dissipation [W]
	20	30	40	50	60	70	80	
75.0	0.95	0.83	0.70	0.58	0.46	0.33	0.21	80.7
67.5	1.13	0.99	0.85	0.71	0.57	0.42	0.28	70.7
60.0	1.31	1.15	0.98	0.82	0.66	0.49	0.33	61.0
52.5	1.55	1.35	1.16	0.97	0.77	0.60	0.39	51.8
45.0	1.86	1.63	1.40	1.16	0.93	0.70	0.47	42.9
37.5	2.32	2.03	1.74	1.45	1.16	0.87	0.58	34.5
30.0	3.02	2.64	2.26	1.88	1.51	1.13	0.75	26.5
22.5	4.21	3.68	3.16	2.63	2.11	1.58	1.05	19.0
15.0	6.68	5.85	5.01	4.18	3.34	2.51	1.67	12.0
7.2	14.53	12.71	10.89	9.08	7.26	5.45	3.63	5.5
	T <sub>A</sub>							
	Ambient temp [°C]							

## Heatsink Selection (cont.)

### RGS1A..9x

Load current [A]	Thermal resistance [K/W]							Power dissipation [W]
	20	30	40	50	60	70	80	
90.0	0.77	0.67	0.56	0.46	0.36	0.26	0.16	98.4
81.0	0.92	0.80	0.69	0.57	0.46	0.34	0.22	85.9
72.0	1.08	0.95	0.81	0.68	0.54	0.41	0.27	74.0
63.0	1.28	1.12	0.96	0.80	0.64	0.48	0.32	62.5
54.0	1.55	1.36	1.61	0.96	0.77	0.58	0.39	51.7
45.0	1.93	1.69	1.45	1.21	0.97	0.73	0.48	41.4
36.0	2.53	2.21	1.89	1.58	1.26	0.94	0.63	31.6
27.0	3.55	3.11	2.66	2.218	1.78	1.33	0.89	22.5
18.0	5.68	4.97	4.26	3.55	2.84	2.13	1.42	14.1
9.0	12.46	10.90	9.34	7.79	6.23	4.67	3.12	6.4

T<sub>A</sub>  
Ambient temp [°C]

## Mounting Instructions

Thermal stress will reduce the lifetime of the SSR. Therefore it is necessary to select the appropriate heatsinks, taking into account the surrounding temperature, load current and the duty cycle.

A small amount of thermally conductive silicone paste must be applied to the back of the SSR. RGS should be mounted on the heatsink with two M5 screws. Gradually tighten each screw (alternating between the two) until both are tightened with a torque of 0.75Nm. For optimal results wait one hour to allow excess paste to be pressed out and then tighten both screws to their final mounting torque of 1.5Nm.

## Short Circuit Protection

### Protection Co-ordination, Type 1 vs Type 2:

Type 1 protection implies that after a short circuit, the device under test will no longer be in a functioning state. In type 2 co-ordination the device under test will still be functional after the short circuit. In both cases, however the short circuit has to be interrupted. The fuse between enclosure and supply shall not open. The door or cover of the enclosure shall not be blown open. There shall be no damage to conductors or terminals and the conductors shall not separate from terminals. There shall be no breakage or cracking of insulating bases to the extent that the integrity of the mounting of live parts is impaired. Discharge of parts or any risk of fire shall not occur.

The product variants listed in the table hereunder are suitable for use on a circuit capable of delivering not more than 100,000A rms Symmetrical Amperes, 600Volts maximum when protected by fuses. Tests at 100,000A were performed with Class J, fast acting; please refer to the table below for maximum allowed ampere rating of the fuse. Use fuses only.

## Co-ordination type 1 (UL508)

Part no.	Max. size [A]	Class	Current [kA]	Voltage [VAC]
RGS..25	30	J	100	Max. 600
RGS..50 / 51	30	J	100	Max. 600
RGS..75 / 71	30	J	100	Max. 600
RGS..90 / 91	30	J	100	Max. 600

Note: For the RGS..50,51,75,71,90,91, the fuse rating are according to the motor rating as required by the UL standard.

## Co-ordination type 2 (IEC EN 60947-4-2/ -4-3)

Part No.	Ferraz Shawmut		Siba		Current [kA]	Voltage [VAC]
	Max size [A]	Part number	Max size [A]	Part number		
RGS..25	32	6.9xx CP URD 22x58/32, (xx=00 or 21)	-	-	100	Max. 600
RGS..50	50	A70QS50-4	50	50 142 06.50	100	Max. 600
RGS..51	50	A70QS50-4	-	-	100	Max. 600
RGS..75	80	A70QS80-4	-	-	100	Max. 600
RGS..71/90/91	100	A70QS100-4	100	50 194 20.100	100	Max. 600

## Thermal Specifications

	RGS..25	RGS..50	RGS..51	RGS..75	RGS..71,90,91
Max. junction temperature	125°C	125°C	125°C	125°C	125°C
Thermal resistance junction to case, R <sub>thjc</sub>	< 0.47 K/W	< 0.32 K/W	< 0.32 K/W	< 0.23 K/W	< 0.22 K/W
Thermal resistance case to heatsink, R <sub>thcs</sub>	< 0.25 K/W	< 0.17 K/W	< 0.17 K/W	< 0.17 K/W	< 0.14 K/W

Note: Thermal resistance case to heatsink values are applicable upon application of a fine layer of silicon based thermal paste HTS02S from Electrolube between SSR and heatsink.



## Protection with Miniature Circuit Breakers

Solid State Relay type	Model no. for Z - type M. C. B. (rated current)	Model no. for B - type M. C. B. (rated current)	Wire cross sectional area [mm <sup>2</sup> ]	Minimum length of Cu wire conductor [m]*	
<b>RGS..25</b>	S201 - Z4 (4A)	S201 - B2 (2A)	1.0	21.0	
	S201 - Z6 UC (6A)	S201 - B2 (2A)	1.0	21.0	
			1.5	31.5	
<b>RGS..50</b> <b>RGS..51</b>	S201 - Z10 (10A)	S201-B4 (4A)	1.0	7.6	
			1.5	11.4	
			2.5	19.0	
	S201 - Z16 (16A)	S201-B6 (6A)	1.0	5.2	
			1.5	7.8	
			2.5	13.0	
			4.0	20.8	
	S201 - Z20 (20A)	S201-B10 (10A)	1.5	12.6	
			2.5	21.0	
	S201 - Z25 (25A)	S201-B13 (13A)	2.5	25.0	
			4.0	40.0	
	S202 - Z25 (25A)	S202-B13 (13A)	2.5	19.0	
			4.0	30.4	
	<b>RGS..75</b>	S201 - Z25 (25A)	S201-B13 (13A)	2.5	7.0
				4.0	11.2
6.0				16.8	
<b>RGS...71, RGS...90,</b> <b>RGS...91</b>	S201 - Z20 (20A)	S201-B10 (10A)	1.5	4.2	
			2.5	7.0	
			4.0	11.2	
	S202 - Z20 (20A)	S202-B10 (10A)	1.5	1.8	
			2.5	3.0	
			4.0	4.8	
	S201 - Z32 (32A)	S201-B16 (16A)	2.5	13.0	
			4.0	20.8	
			6.0	31.2	
	S202 - Z32 (32A)	S202-B16 (16A)	2.5	5.0	
			4.0	8.0	
			6.0	12.0	
			10.0	20.0	
	S202 - Z50 (50A)	S202-B25 (25A)	4.0	14.8	
			6.0	22.2	
10.0			37.0		

4. between MCB and SSR Relay (including return path which goes back to the mains).

Note: A prospective current of 6kA and a 230/400V power supply system is assumed for the above suggested specifications. For cables with different cross section than those mentioned above please consult Carlo Gavazzi's Technical Support Group.